

SLIDING DOOR

TB SERIES - 125mm FRAME



Sliding doors are one of the most popular ways of joining interior living spaces & outdoor entertainment areas. The slimline layout results in a minimal intrusion into rooms, walkways or verandahs. With sliding screens fitted as standard, they also provide excellent ventilation, capturing cool cross-breezes in summer



All panels roll on two heavy duty - 80kg rated - ball-bearing carriages, which run on an anodised track insert

TB Series products feature thermally broken frames. The thermal break minimises heat transfer through the frame, resulting in a very energy efficient product

The optional external frame infill has a 15 x 12mm pocket for flashing insertion, whilst the inline reveal simplifies installation into a broad range of construction styles. Reveals can be supplied as primed or raw hardwood, & can be offset by 1.6mm from the aluminium to assist in creating a 'square-set' look.

The secure lock assembly features anti-lift pins & is key lockable from both sides. It is available in a black, white or silver finish



SLIDING DOOR

TB SERIES - 125mm FRAME

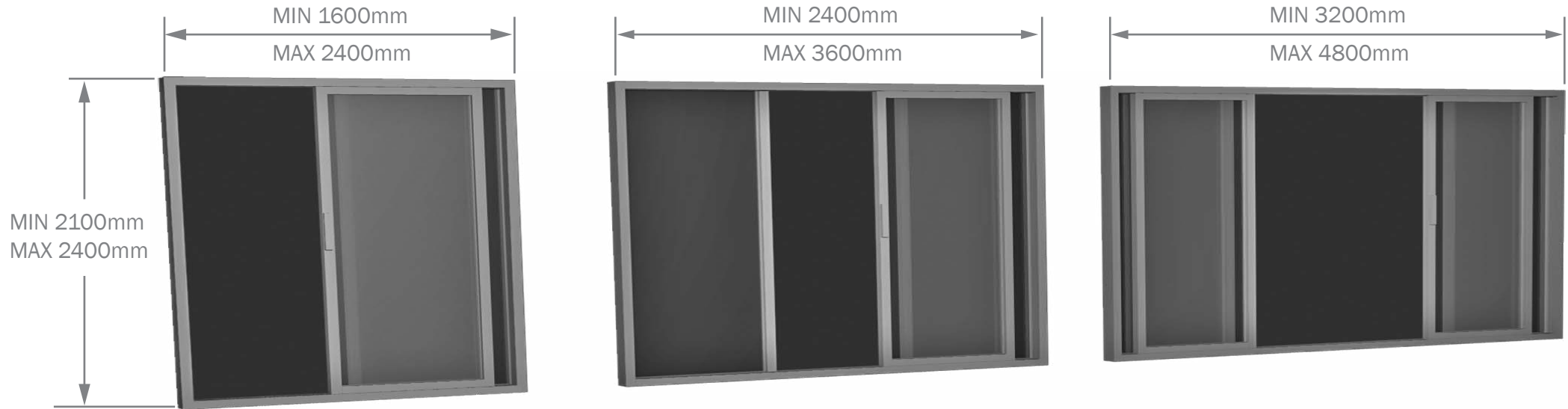

NOTE: ALL SIZES ARE TYPICAL RATHER THAN DEFINITIVE. FOR SIZES OUTSIDE OF THESE PLEASE DISCUSS WITH YOUR RYLOCK SALES CONSULTANT

Sizing

Door style & opening detail should be considered as viewed externally
Sizes indicated are the overall door size. For Stud openings add 20mm to both height & width

Glazing

Glazing strength to minimum N3 rating
Glazing to be grade A safety glass. Double glazed only, where the maximum panel thickness is 22.38mm

Certification

Certified performance data is available for this product on request

Specify

Frame colour, configuration, height, width & overall depth, reveal type (primed hardwood, raw hardwood, or setup for plaster reveals)

Optional: handle type & colour, fly screen, mesh type, external frame infill, reveal equaliser (head & jambs only), sill flap, glass type

The above product sizes comply with structural requirements (AS2047-2014, *Windows and external glazed doors in buildings*) for an 'N1' wind rating (AS4055-2012, *Wind loads for housing*).

This is typical of sites in suburban areas. In addition, the location has a Terrain Category of 3, is Topographic Class 1 or 2 and assumes the building will be surrounded by others of similar size.

Please specify if your site has different characteristics to any of those listed. Your building professional (architect, designer, surveyor, engineer, builder, etc.) can often assist with such determinations.